



SF1601G THRU SF1608G

16.0 AMPS. Glass Passivated Super Fast Rectifiers



Voltage Range
50 to 600 Volts
Current
16.0 Amperes

Features

- ✧ Low forward voltage drop
- ✧ High current capability
- ✧ High reliability
- ✧ High surge current capability

Mechanical Data

- ✧ Cases: Molded plastic
- ✧ Epoxy: UL 94V-O rate flame retardant
- ✧ Terminals: Leads solderable per MIL-STD-202, Method 208 guaranteed
- ✧ Polarity: As marked
- ✧ High temperature soldering guaranteed: 260°C/10 seconds .16", (4.06mm) from case.
- ✧ Weight: 2.24 grams

TO-220

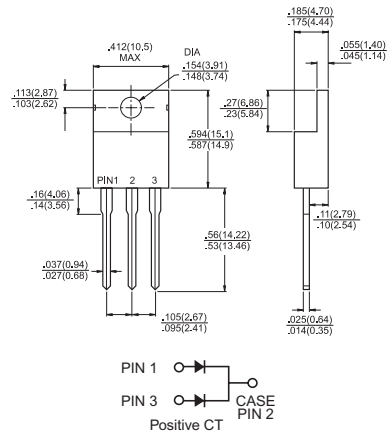

Dimensions in inches and (millimeters)

Maximum Ratings and Electrical Characteristics

Rating at 25°C ambient temperature unless otherwise specified.

Single phase, half wave, 60 Hz, resistive or inductive load.

For capacitive load, derate current by 20%

| Type Number | Symbol | SF 1601G | SF 1602G | SF 1603G | SF 1604G | SF 1605G | SF 1606G | SF 1607G | SF 1608G | Units |
|--|-------------------|-------------|----------|----------|----------|----------|----------|----------|----------|----------|
| Maximum Recurrent Peak Reverse Voltage | V_{RRM} | 50 | 100 | 150 | 200 | 300 | 400 | 500 | 600 | V |
| Maximum RMS Voltage | V_{RMS} | 35 | 70 | 105 | 140 | 210 | 280 | 350 | 420 | V |
| Maximum DC Blocking Voltage | V_{DC} | 50 | 100 | 150 | 200 | 300 | 400 | 500 | 600 | V |
| Maximum Average Forward Rectified Current @ $T_C = 100^\circ\text{C}$ | $I_{(AV)}$ | 16.0 | | | | | | | | A |
| Peak Forward Surge Current, 8.3 ms Single Half Sine-wave Superimposed on Rated Load (JEDEC method) | I_{FSM} | 125 | | | | | | | | A |
| Maximum Instantaneous Forward Voltage @ 8.0A | V_F | 0.975 | | | 1.3 | | 1.7 | | | V |
| Maximum DC Reverse Current @ $T_A=25^\circ\text{C}$ at Rated DC Blocking Voltage @ $T_A=100^\circ\text{C}$ | I_R | 10 | | | | 400 | | | | uA uA |
| Maximum Reverse Recovery Time (Note 1) | T_{rr} | 35 | | | | | | | | nS |
| Typical Junction Capacitance (Note 2) | C_j | 80 | | | | 60 | | | | pF |
| Typical Thermal Resistance (Note 3) | $R_{\theta_{JC}}$ | 1.5 | | | | | | | | °C/W |
| Operating Temperature Range | T_J | -65 to +150 | | | | | | | | °C |
| Storage Temperature Range | T_{STG} | -65 to +150 | | | | | | | | °C |

- Notes: 1. Reverse Recovery Test Conditions: $I_F=0.5A$, $I_R=1.0A$, $I_{RR}=0.25A$
 2. Measured at 1 MHz and Applied Reverse Voltage of 4.0 V D.C.
 3. Mounted on Heatsink Size of 3 in x 5 in x 0.25 in Al-Plate.

RATINGS AND CHARACTERISTIC CURVES (SF1601G THRU SF1608G)

FIG. 1- REVERSE RECOVERY TIME CHARACTERISTIC AND TEST CIRCUIT DIAGRAM

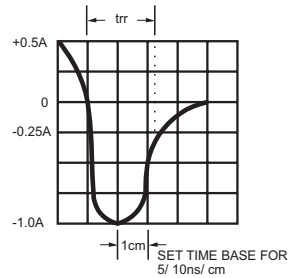
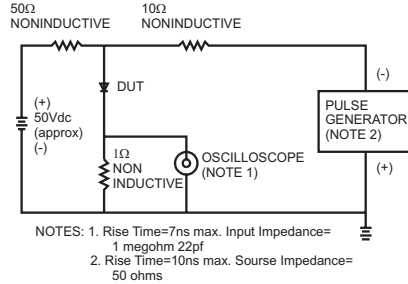

FIG.2- MAXIMUM FORWARD CURRENT DERATING CURVE

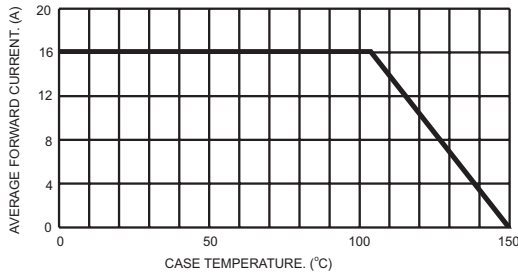

FIG.3- TYPICAL REVERSE CHARACTERISTICS

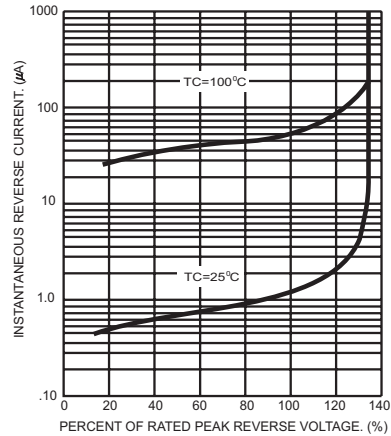

FIG.4- MAXIMUM NON-REPETITIVE FORWARD SURGE CURRENT PER LEG

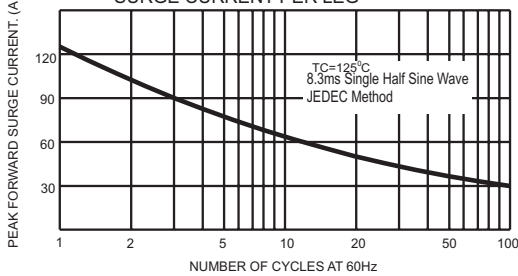

FIG.6- TYPICAL FORWARD CHARACTERISTICS PER LEG

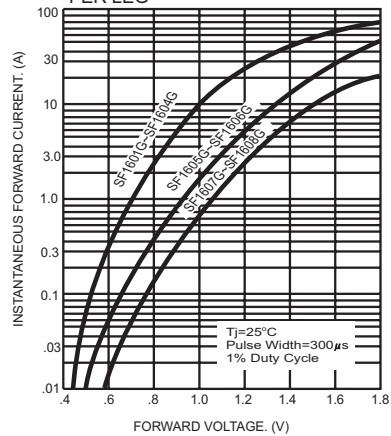
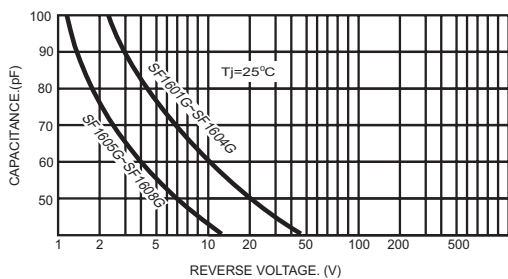

FIG.5- TYPICAL JUNCTION CAPACITANCE PER LEG



This datasheet has been download from:

www.datasheetcatalog.com

Datasheets for electronics components.